

Three-Dimensional Hückel Theory for *closo*-Carboranes

Benjamin M. Gimarc* and Ming Zhao

Department of Chemistry and Biochemistry, University of South Carolina,
Columbia, South Carolina 29208

Received June 1, 1995[⊗]

We have recently developed a 3-dimensional Hückel method for cluster compounds. The method uses a set of approximations for Coulomb, resonance, and overlap integrals very similar to those employed in the familiar 2-dimensional Hückel theory for the π electrons of planar conjugated hydrocarbons. The method can be adapted to heteroatomic clusters by introducing heteroatomic Coulomb integrals, $\alpha_Y = \alpha_X + h\beta$, where h is a parameter for heteroatom Y. In this paper, we use the 3-dimensional Hückel method to study the properties of the *closo*-carboranes, $C_2B_{n-2}H_n$. We calibrate the method by choosing a value of the heteroatomic parameter h that distinguishes positional isomers by energy and gives them relative energies in rough agreement with those established by observation and *ab initio* calculations. We obtain modest improvement in matching *ab initio* relative energies of isomers by means of a three-parameter, first-order perturbation treatment. We use the calibrated method to evaluate various mechanisms proposed for the isomerizations of $C_2B_4H_6$, $C_2B_5H_7$, and $C_2B_6H_8$, all of which have been observed to undergo intramolecular isomerizations. Rearrangements of $C_2B_6H_8$ have been satisfactorily explained by a single-DSD (diamond–square–diamond) process. Those for $C_2B_5H_7$ require at least two DSD processes, concerted, consecutive, or overlapping. Several different mechanisms have been proposed for the rearrangement of $C_2B_4H_6$. In evaluating intermediate and transition state structures, the 3-dimensional Hückel method gives higher energies to those structures with a larger number of nontriangular faces, a plausible conclusion except that occasionally it is wrong. In comparison with *ab initio* results, the 3-dimensional Hückel method fails to give low energies for classical structures.

Introduction

In this paper we use a 3-dimensional Hückel method that we have recently developed and described elsewhere^{1,2} to study some of the properties of the *closo*-carboranes ($C_2B_{n-2}H_n$, $n = 5-12$), a series of 52 isomers that fall into eight polyhedral classes.^{3,4} But why 3-dimensional Hückel theory? It is true that much more accurate and complete electronic structure methods are available and indeed have already been used to study some of the properties of the *closo*-carboranes. Because the *closo*-carboranes provide such a large number of related structures for which a considerable amount of experimental and theoretical data have already been determined, these molecules constitute an exceptional series for calibrating 3-dimensional Hückel theory and evaluating its effectiveness. If a simple theoretical model can reproduce trends established by experimental observations and more fundamental theoretical methods, then the simple theory may allow quick surveys of new areas of chemistry and point the way for more intensive calculations and experiments. Furthermore, the details of heavy computations occasionally obscure the visualization of chemical concepts. The simple Hückel method starts with little more information than statements of which atoms are bonded to each other and how many electrons are involved in bonding. Chemists routinely specify bonds and count electrons in making qualitative predictions or rationalizations concerning molecular structures. It is instructive and gratifying to discover how far one can go with a semiquantitative but quantum mechanically

based model that starts from initial assumptions of atom connectivity and electron count. We briefly review 3-dimensional Hückel theory and calibrate the method for the *closo*-carboranes, compare relative energies of isomers within the eight polyhedral clusters as determined by experiment and *ab initio* and 3-dimensional Hückel calculations, and evaluate proposed isomerization mechanisms for *closo*-carborane polyhedra with six, seven, and eight atoms.

3-Dimensional Hückel Theory

For many years the simple Hückel theory or the standard 2-dimensional π molecular orbital (MO) method has been the basis for qualitative insights into the structures and other properties of planar conjugated molecules in both organic chemistry^{5,6} and inorganic chemistry.⁷⁻⁹ Realization that the method is based on atomic connectivity or topology and the number of π electrons has led to a brilliant reformulation of simple Hückel theory in terms of graph theory.^{10,11} Recently we have described a 3-dimensional Hückel method for cluster compounds and showed that it can be successfully applied to the study of structures and relative stabilities of the *closo*-boranes and to certain classes of transition metal clusters.^{1,2} This 3-dimensional Hückel theory is not to be confused with the extended Hückel method^{12,13} or other methods that have been

[⊗] Abstract published in *Advance ACS Abstracts*, January 15, 1996.

(1) Zhao, M.; Gimarc, B. M. *Inorg. Chem.* **1993**, *32*, 4700.

(2) Joseph, J.; Gimarc, B. M.; Zhao, M. *Polyhedron* **1993**, *12*, 2841.

(3) Williams, R. E. In *Progress in Boron Chemistry*; Brotherton, R. J., Steinberg, H., Eds.; Pergamon: Oxford, 1970; Vol. 2, p 37. Williams, R. E. In *Advances in Organometallic Chemistry*; Stone, F. G. A., West, R., Eds.; Academic Press: San Diego, CA, 1994; Vol. 36, p 1.

(4) Williams, R. E.; Gerhart, F. *J. Am. Chem. Soc.* **1965**, *87*, 3513.

(5) Streitwieser, A., Jr. *Molecular Orbital Theory for Organic Chemists*; Wiley: New York, 1961.

(6) Coulson, C. A.; O'Leary, B.; Mallion, R. B. *Hückel Theory for Organic Chemists*; Academic Press: New York, 1978.

(7) Coulson, C. A.; Dingle, T. W. *Acta Crystallogr.* **1968**, *B24*, 153.

(8) Gimarc, B. M.; Trinajstić, N. *Pure Appl. Chem.* **1980**, *52*, 1443.

(9) Gimarc, B. M. *Croat. Chem. Acta* **1984**, *57*, 955.

(10) Graovac, A.; Gutman, I.; Trinajstić, N. *Topological Approach to the Chemistry of Conjugated Molecules*; Springer-Verlag: Berlin, 1977.

(11) Trinajstić, N. *Chemical Graph Theory*; CRC Press: Boca Raton, FL, 1983.

(12) Hoffmann, R. *J. Chem. Phys.* **1963**, *39*, 1397.

referred to as 3-dimensional Hückel methods.¹⁴ Our method is a true successor to 2-dimensional, simple Hückel theory in that the input for a calculation consists of nothing more than the specification of atomic connectivity through an adjacency matrix and the number of electrons assumed to be involved in cluster bonding. Resulting MO energies are expressed in units of a standard (but unspecified) resonance integral β , and the zero of energy is the average of standard Coulomb integrals α , just as in 2-dimensional Hückel theory.

The atomic orbital (AO) basis set for 3-dimensional Hückel theory was originally proposed by Wade¹⁵ and elaborated by King and Rouvray.¹⁶ Stone has developed a surface tensor harmonic theory for cluster compounds based on the model of a free electron on the surface of a sphere.¹⁷ Imagine a polyhedral molecule composed of n cluster framework atoms, each of which contributes one s and three p valence AOs. For each atom assume a coordinate system such that one p AO, called the *radial orbital*, points toward the center of the polyhedron while the remaining two p AOs, called *tangential orbitals*, point parallel to the surface of the sphere that encloses the polyhedron. The radial p AO can be combined with the s AO to form two hybrid AOs, an *inner orbital* that points toward the center of the polyhedron and an *external orbital* that is directed out and normal to the surface of the sphere around the polyhedron. The external orbital can be used to form a normal electron pair bond to an external substituent or to hold a lone pair of electrons. Therefore the external orbital is assumed to be not involved in cluster bonding. The two tangential p AOs and the internal radial hybrid orbital on each atom in the n -atom cluster framework give a basis set of $3n$ AOs $\{\chi_r\}$ with which to form $3n$ MOs $\{\phi_i\}$, where

$$\phi_i = \sum_r c_{ri} \chi_r$$

to describe cluster bonding. Solution of the secular determinant

$$|H_{rs} - \epsilon_i S_{rs}| = 0$$

to obtain the MOs ϕ_i and orbital energies ϵ_i requires only standard Hückel assumptions for specification of Coulomb integrals,

$$H_{rr} = \alpha_r = \langle \chi_r | H | \chi_r \rangle$$

resonance integrals,

$$H_{rs} = \beta_{rs} = \langle \chi_r | H | \chi_s \rangle$$

and overlap integrals

$$S_{rs} = \langle \chi_r | \chi_s \rangle$$

We assume that the AOs χ_r are normalized, but we neglect all overlap integrals.

$$S_{rs} \begin{cases} = 1, & r = s \\ = 0, & r \neq s \end{cases}$$

We neglect resonance integrals if orbitals χ_r and χ_s are not on atoms connected by a bond, or $\beta_{rs} = 0$, if r and s are not adjacent. Between bonded atoms we can identify four standard

types of resonance integrals β between pairs of radial and tangential orbitals χ_r and χ_s . For convenience we assume that these interactions are adequately described by the same β . We do modify the standard β according to geometrically determined phase relationships between interacting adjacent AOs. In 3-dimensional Hückel theory, we might wish to distinguish between the Coulomb integrals for the internal radial orbital α_R and those for the tangential orbitals α_T . To maintain an average of zero for Coulomb integrals, we set $\alpha_R + 2\alpha_T = 0$. The difference ($\delta\alpha$) between α_R and α_T can be related to the standard resonance integral β multiplied by an adjustable parameter (k): $\delta\alpha = \alpha_R - \alpha_T = k\beta$. Furthermore, we might choose to introduce one or more heteroatoms Y into an otherwise homoatomic cluster of atoms X . Again, for convenience we assume resonance integrals β are the same irrespective of bond type, XX , XY , or YY , but we establish the difference between Coulomb integrals α_X and α_Y as β multiplied by an adjustable parameter (h): $\Delta\alpha = \alpha_Y - \alpha_X = h\beta$ or $\alpha_Y = \alpha_X + h\beta$, just as is done for heteroatoms in 2-dimensional Hückel theory. MO energies ϵ_i , obtained from solution of the secular determinant, are expressed in units of the standard resonance integral β , the value of which need not be specified. Finally, the total energy E of the molecule is the sum of orbital energies ϵ_i for all electrons: $E = \sum_i \epsilon_i$. The 3-dimensional Hückel method has been programmed in FORTRAN for operation on a personal computer.

In recent papers we have described the use of the 3-dimensional Hückel model to study properties of the *closo*-boranes, $B_n H_n^{2-}$, $n = 5-12$, and certain classes of transition metal clusters.^{1,2} In particular, the method was able to select, on the basis of lowest total energy, the experimentally observed structure of each *closo*-borane from among a variety of plausible polyhedral structures. The 3-dimensional Hückel total energies per cluster atom (E/n) correlate extremely well with those from *ab initio* SCF MO calculations. The numbers of electron pairs found to be occupying bonding MOs turned out to be $n + 1$, in agreement with Wade's empirical rules.¹⁵ B-B bond distances in the *closo*-boranes vary widely, but Coulson bond orders from 3-dimensional Hückel calculations correlate quite well with bond distances from experiment and geometry-optimized *ab initio* results. For certain six-atom transition metal clusters, the 3-dimensional Hückel results permitted the rationalization of empirically observed numbers of cluster bonding electron pairs that deviate from the $n + 1$ rule. We have used the 3-dimensional Hückel method to produce MO energy level correlation diagrams that describe polyhedral rearrangements of clusters including examples from both organic chemistry and main-group inorganic chemistry.¹⁸ The correlation diagrams provide visual rationalizations of observed structural trends with different numbers of cluster electrons.

Relative Energies of Carborane Isomers

The *closo*-carboranes, $C_2 B_{n-2} H_n$, $n = 5-12$, have structures in which all polyhedral faces are triangular, a feature that allows these structures to be called *deltahedral*. These elegant structures have considerable aesthetic appeal. Figure 1 displays the eight deltahedral forms and establishes the numbering system that we use to specify the locations of the pair of carbon heteroatoms within the polyhedral framework. The different possible sites for the location of two carbons in each polyhedral frame give rise to two or more positional isomers in each of the eight cluster classes. At least one isomer has been identified experimentally in each class, with 15 known isomers out of a

(13) Hoffmann, R.; Lipscomb, W. N. *J. Chem. Phys.* **1962**, *36*, 3489.

(14) Haddon, R. C. *J. Am. Chem. Soc.* **1987**, *109*, 1676.

(15) Wade, K. *J. Chem. Soc., Chem. Commun.* **1971**, 792; *Adv. Inorg. Chem. Radiochem.* **1976**, *18*, 1.

(16) King, R. B.; Rouvray, D. H. *J. Am. Chem. Soc.* **1977**, *99*, 7834.

(17) Stone, A. J. *Inorg. Chem.* **1981**, *20*, 563.

(18) Gimarc, B. M.; Zhao, M. *Polyhedron* **1995**, *14*, 1315.

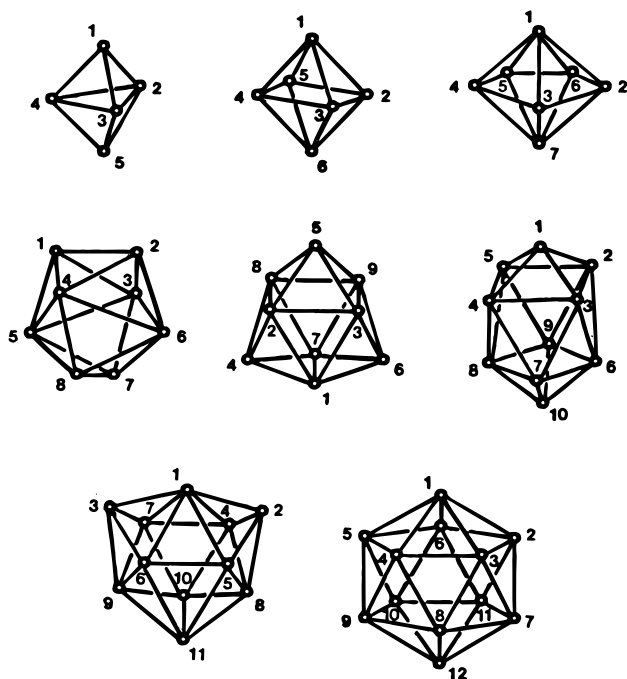

Figure 1. Deltahedral structures and numbering conventions for the *closo*-carboranes, $C_2B_{n-2}H_n$.

Table 1. Numbers of Possible and Known Positional Isomers Among the Eight Polyhedral Classes of *closo*-Carboranes^a

	n							total	
	5	6	7	8	9	10	11		12
Possible	3	2	4	7	6	7	20	3	52
Known	2	2	2	1	1	3	1	3	15

^a An enantiomeric pair is counted as a single isomer in these totals.

total of 52 possible isomers. Table 1 sets out the numbers of known and possible isomers in each class. Geometry-optimized *ab initio* SCF MO calculations at the STO-3G level have been reported for all 52 positional isomers.^{19–22} Although these calculations employed a minimal basis set and included no corrections for the effects of electron correlation, one can hope and reasonably expect that basis set and correlation errors will be about the same when comparing positional isomers within a particular cluster class because all the isomers have the same polyhedral form. Positional isomers have different relative energies. Here we attempt to discover how well relative stabilities of positional isomers based on 3-dimensional Hückel total energies agree with stability orders established by *ab initio* calculations and with experiment, where known.

Before we can make these comparisons, it is necessary for us to calibrate the 3-dimensional Hückel model. For convenience we set $\delta\alpha = \alpha_R - \alpha_T = 0$ for Coulomb integrals of both carbon and boron. To distinguish between carbon and boron, however, we choose different Coulomb integrals for carbon and boron such that $\Delta\alpha = \alpha_C - \alpha_B = h\beta$. If α and β are both inherently negative quantities and $h > 0$, then the order of differences implies $\alpha_C < \alpha_B$ or that the carbon Coulomb integral is deeper in energy than that of boron, reflecting a larger ionization energy for carbon than for boron. In practice, h is the heteroatom parameter for carbon, and its value goes into

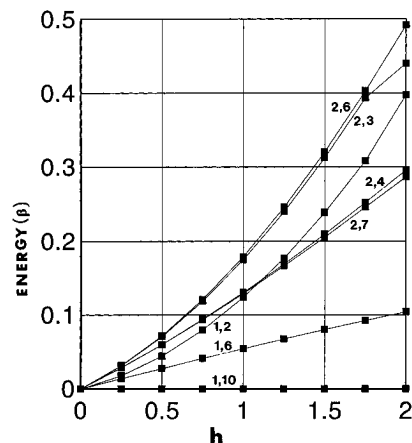

Figure 2. Relative energies of the seven possible $C_2B_8H_{10}$ isomers as functions of the carbon heteroatom parameter $h = \Delta\alpha/\beta$, $\Delta\alpha = \alpha_C - \alpha_B$. The observed isomers are, in increasing energy, 1,10, 1,6, and 1,2.

the diagonal elements of the adjacency matrix corresponding to numberings for carbon AOs, while the diagonal elements for boron AOs are occupied by zeros. To calibrate the model, we carried out a series of calculations for $C_2B_8H_{10}$ which has seven possible positional isomers, three of which have been prepared and characterized. Figure 2 shows the relative energies of the seven positional isomers as functions of the parameter $h = \Delta\alpha/\beta$. For $h = 0$, all atoms are borons and all isomers have the same energy. But as h increases, turning on the perturbation that makes carbon atoms different from borons, the energies split. For $h = 0.5$, the three isomers of lowest calculated total energy, 1,10 < 1,6 < 1,2, are the three isomers known from experiment, and they have the same relative energies inferred from observations of thermal rearrangements. On heating, the 1,2-isomer rearranges to the 1,6-isomer, which on further heating isomerizes to the 1,10-isomer.^{23–26} This order differs only slightly from that obtained from *ab initio* calculations which show that the unknown 2,7-isomer is lower in energy than the known 1, 2-isomer by <1 kcal/mol. As explained elsewhere, this difference in energy order does not affect the argument about relative energies of observed isomers.²¹

Because the value $h = 0.5$ gives a reasonable differentiation between the seven isomers of $C_2B_8H_{10}$, whose relative energies fit a pattern widely assumed to exist on the basis of observed rearrangement patterns, we have used the value $h = 0.5$ in calculations of the other carboranes. Table 2 lists the relative energies of the various *closo*-carboranes obtained by the 3-dimensional Hückel method and compared with results from *ab initio* SCF MO calculations at the STO-3G level. Printed in boldface under the isomer heading (left column) are the 15 isomers that are observed experimentally. In every case the 3-dimensional Hückel calculations give lowest energies to these known isomers. The middle column of Table 2 contains the 3-dimensional relative energies (in units of β) of carborane isomers in increasing energy down the column within each cluster class, $n = 5–12$. The right-hand column displays *ab initio* relative energies (in kcal/mol) of the corresponding carboranes. Orders of stabilities from the two computational methods match exactly only for $n = 5, 6, 7$, and 9. Boldface

(19) Ott, J. J.; Gimarc, B. M. *J. Comput. Chem.* **1986**, *7*, 673.

(20) Gimarc, B. M.; Dai, B.; Ott, J. J. *J. Comput. Chem.* **1988**, *10*, 14.

(21) Gimarc, B. M.; Ott, J. J. *J. Am. Chem. Soc.* **1987**, *109*, 1388.

(22) Gimarc, B. M.; Dai, B.; Warren, D. S.; Ott, J. J. *J. Am. Chem. Soc.* **1990**, *112*, 2597.

(23) Tebbe, F. N.; Garrett, P. M.; Young, D. C.; Hawthorne, M. F. *J. Am. Chem. Soc.* **1966**, *88*, 609.

(24) Garrett, P. M.; Smart, J. C.; Hawthorne, M. F. *J. Am. Chem. Soc.* **1969**, *91*, 4707.

(25) Rietz, R. R.; Schaeffer, R.; Walter, E. *J. Organomet. Chem.* **1973**, *63*, 1.

(26) Garrett, P. M.; Smart, J. C.; Ditta, G. S.; Hawthorne, M. F. *Inorg. Chem.* **1969**, *8*, 1907.

Table 2. Relative Energies of *closo*-Carborane Isomers as Obtained by the 3-Dimensional Hückel Theory and *ab Initio* Calculations by Direct Solution of Secular Equation, $h = 0.5$

isomer	3-D Hückel ($ \beta $)	<i>ab initio</i> (kcal/mol)
1,5-C ₂ B ₃ H ₅	0.	0.
1,2-	0.0669	53.5
2,3	0.1130	85.1
1,6-C ₂ B ₄ H ₆	0.	0.
1,2-	0.0145	9.8
2,4-C ₂ B ₅ H ₇	0.	0.
2,3-	0.0209	24.2
1,2-	0.0247	49.8
1,7-	0.0248	79.8
1,7-C ₂ B ₆ H ₈	0.	0.
1,6-	0.0117	27.6
3,4-	0.0233	63.3
1,3-	0.0234	37.1
1,2-	0.0252	29.5
1,5-	0.0288	53.8
3,5-	0.0342	81.0
4,5-C ₂ B ₇ H ₉	0.	0.
3,4-	0.0290	19.9
1,4-	0.0454	42.6
1,8-	0.0619	53.1
1,2-	0.0712	74.3
1,7-	0.0733	75.1
1,10-C ₂ B ₈ H ₁₀	0.	0.
1,6-	0.0274	28.1
1,2-	0.0442	54.0
2,7-	0.0597	53.2
2,4-	0.0599	61.0
2,3-	0.0706	74.0
2,6-	0.0717	73.7
2,3-C ₂ B ₉ H ₁₁	0.	0.
2,6-	0.0163	24.6
2,9-	0.0179	19.8
2,10-	0.0209	24.5
2,8-	0.0290	51.6
1,2-	0.0346	67.4
8,9-	0.0361	47.8
4,9-	0.0367	51.9
2,4-	0.0370	58.5
4,5-	0.0385	58.1
4,6-	0.0394	47.7
4,11-	0.0420	51.6
1,8-	0.0433	81.0
1,10-	0.0482	74.4
4,7-	0.0490	65.7
4,8-	0.0490	77.3
1,4-	0.0531	91.0
8,10-	0.0538	76.3
4,10-	0.0549	75.5
10,11-	0.0564	64.8
1,7-C ₂ B ₁₀ H ₁₂	0.	0.
1,12-	0.0020	-4.57
1,2-	0.0129	31.34

entries in the column of *ab initio* energies highlight order differences compared to the 3-dimensional Hückel column. The most serious discrepancy occurs among the $n = 12$ isomers. Observed²⁷ and *ab initio*¹⁹ orders agree on the increasing energy order $1,12 < 1,7 < 1,2$, while the 3-dimensional Hückel method reverses the stability order of 1,12 and 1,7. But the energy difference between these two isomers at the STO-3G level is small, < 5 kcal/mol. The 3-dimensional Hückel order, 1,7 below 1,12, is stable with respect to variations in the carbon heteroatom parameter h . We also tried to reverse the order by including differences between radial and tangential Coulomb integrals by introducing values of the parameter $k = \delta\alpha/\beta$ different from zero but with no effect.

Relative energies are closely spaced among the 20 possible isomers of C₂B₉H₁₁. Table 2 reveals many order discrepancies

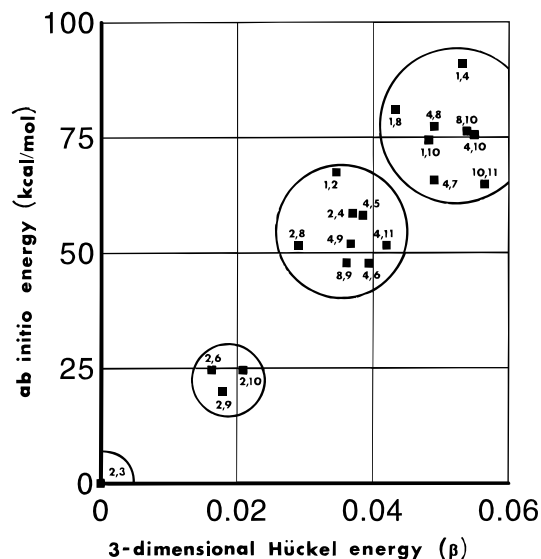

Figure 3. *Ab initio* SCF MO relative energies plotted against 3-dimensional Hückel relative energies for the 20 possible isomers of C₂B₉H₁₁ for $h = 0.5$. The isomers fall into four rather distinct clusters. The only isomer that has been observed, 2,3-C₂B₉H₁₁, constitutes a cluster of only one member at the origin.

between 3-dimensional Hückel and *ab initio* results. Figure 3 plots 3-dimensional Hückel relative energies along the abscissa against *ab initio* relative energies on the ordinate. In Figure 3 the 20 isomers of C₂B₉H₁₁ fall into four rather distinct clusters. The lowest energy isomer, 2,3, constitutes a cluster of only one member at the origin. In an earlier study of relative energies of the 20 isomers of C₂B₉H₁₁, comparisons were made among relative isomer energies based on *ab initio* energies, the rule of topological charge stabilization, and a set of empirical valence rules.²² That study resolved the 20 isomers into six groups, I–VI. It is interesting to compare those six groups with the four clusters of Figure 3. All four methods pick out the known isomer 2,3 as the unique member of group I. *Ab initio*, 3-dimensional Hückel, and empirical valence rules select the same three isomers as members of the second cluster or group II. The third cluster in Figure 3 is a combination of groups III and IV, and the fourth cluster is a merger of V and VI. Since the specific memberships of groups III–VI showed considerable variation as to different methods of the earlier study, the resolution of isomers into clusters of different stabilities as shown in Figure 3 is acceptable.

In our study of the *closo*-boranes, B_{*n*}H_{*n*}²⁻, we showed that the ratio of total energy to polyhedral size, E/n , from the 3-dimensional Hückel method exactly follows the trend of *ab initio* results.¹ By matching the end points of the two sets of results (Figure 4, ref 1), we can estimate the value of the resonance integral, $\beta \sim 100$ kcal/mol. Matching the ranges of energies of the *closo*-carboranes obtained from 3-dimensional Hückel and *ab initio* calculations (Table 2) gives values of β that range from several hundred to a few thousand kcal/mol. By varying the heteroatom parameter h we can force the resulting energy ranges to give $\beta \sim 100$ kcal/mol. Appropriate values are around $h \sim 4$. Unfortunately, choosing values of h that make β agree with the *closo*-borane resonance integral produces seriously misaligned orders of carborane isomer relative stabilities. Therefore, we have rejected values of h chosen to match the *closo*-borane β .

Another way to calculate relative energies of carborane isomers is to apply a qualitative perturbation treatment. For a homoatomic *closo*-borane, the total energy can be written as

$$E = \sum_r q_r \alpha_r + 2 \sum_{r<s} p_{rs} \beta_{rs}$$

where q_r is the Coulson charge density of atom r and p_{rs} is the Coulson bond order of the $r-s$ bond. If we introduce one or more carbon heteroatoms, the resulting change in energy is given by the first-order perturbation expression:

$$\Delta E = \sum_r q_r \Delta \alpha_r + 2 \sum_{r<s} p_{rs} \Delta \beta_{rs}$$

The q_r and p_{rs} quantities come from the 3-dimensional Hückel results for the unperturbed *closo*-borane cluster, and the quantitative $\Delta \alpha_C$, $\Delta \beta_{CC}$, and $\Delta \beta_{BC}$ can be obtained by fitting 3-dimensional Hückel values of ΔE to those from *ab initio* results. To test this approach we used a linear regression analysis to pick $\Delta \alpha_C$, $\Delta \beta_{CC}$, and $\Delta \beta_{BC}$ to optimize the match of 3-dimensional Hückel relative energies for the 20 positional isomers of $C_2B_9H_{11}$ with those from *ab initio* calculations. Subsequently we used the resulting parameter values to calculate relative energies of isomers in the remaining seven classes of carboranes. Results appear in Table 3. As one might expect, the perturbation results, based on three adjustable parameters, are better than those from the direct method using the single parameter $h = 0.5$. The perturbation treatment does not produce energy order discrepancies for $n = 8$, but some still occur in the $n = 10, 11$, and 12 polyhedral classes. For $n = 12$ the 3-dimensional Hückel perturbation treatment gives equal energies for the two isomers of lowest energy. Figure 4 plots 3-dimensional first-order perturbational relative isomer energies for $C_2B_9H_{11}$ against comparable results from *ab initio* calculations. This is the polyhedral class for which the perturbation parameters $\Delta \alpha_C$, $\Delta \beta_{CC}$, and $\Delta \beta_{BC}$ were determined. The points in Figure 4 show a much tighter fit than those in Figure 3. Because the perturbation treatment gives only a modest improvement, we have not used it further in this paper.

Mechanisms of Isomerization

One of the most fascinating properties of the *closo*-carboranes is the ability of isomers among some polyhedral classes to interconvert, with greater or lesser ease, while others do not. The observed isomerizations appear to be the results of intramolecular framework reorganizations in which some bonds break and new bonds form allowing carbon atoms to move to different structural sites while restoring the original polyhedral form. In 1966, Lipscomb proposed a general mechanism for these rearrangements called the diamond-square-diamond (DSD) mechanism.²⁸ Start with a diamond formed by two fused triangular faces. Suppose the shared edge between the two triangles disappears giving a square face, and then a new edge forms perpendicular to the lost edge to regenerate a diamond but with a different orientation as shown in eq 1. The edge or

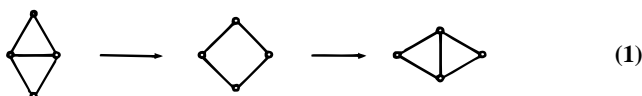

bond that changes positions is sometimes called the *switching edge*, and the square intermediate is the *pivot face*. The DSD mechanism has been the focus of studies concerning the rearrangements of *closo*-boranes and -carboranes for almost 30 years. King recognized that a single-DSD process could regenerate the starting polyhedron only if the difference in sums of valences of atoms at opposite corners of the diamond differ

Table 3. Relative Energies of *closo*-Carborane Isomers as Obtained by First-Order Perturbation of 3-Dimensional Hückel Theory and *ab initio* Calculations

isomer	3D Hückel (kcal/mol)	<i>ab initio</i> (kcal/mol)
1,5-C ₂ B ₃ H ₅	0.0	0.0
1,2-	57.4	53.5
2,3-	82.3	85.1
1,6-C ₂ B ₄ H ₆	0.0	0.0
1,2-	25.2	9.8
2,4-C ₂ B ₅ H ₇	0.0	0.0
2,3-	27.2	24.2
1,2-	48.3	49.8
1,7-	51.3	79.8
1,7-C ₂ B ₆ H ₈	0.0	0.0
1,6-	26.5	27.6
1,2-	28.4	29.5
1,3-	48.8	37.1
1,5-	51.4	53.8
3,4-	53.1	63.3
3,5-	74.3	81.0
4,5-C ₂ B ₇ H ₉	0.0	0.0
3,4-	26.9	19.9
1,4-	51.2	42.6
1,8-	53.9	53.1
1,2-	74.3	74.3
1,7-	75.5	75.1
1,10-C ₂ B ₈ H ₁₀	0.0	0.0
1,6-	24.5	28.1
2,7-	48.9	53.2
2,4-	48.9	61.0
1,2-	49.0	54.0
2,3-	70.3	74.0
2,6-	70.0	73.7
2,3-C ₂ B ₉ H ₁₁	0.0	0.0
2,9-	22.4	19.8
2,10-	24.3	24.5
2,6-	25.3	24.6
8,9-	44.7	47.8
2,8-	45.5	51.6
4,9-	47.7	51.9
4,11-	49.6	51.6
4,6-	50.6	47.7
4,5-	50.6	58.1
2,4-	51.0	58.5
4,8-	67.8	77.3
8,10-	68.8	76.3
10,11-	69.8	64.8
1,2-	70.3	67.4
1,8-	71.1	81.0
4,10-	71.2	75.5
4,7-	73.0	65.7
1,10-	73.1	74.4
1,4-	93.8	91.0
1,12-C ₂ B ₁₀ H ₁₂	0.0	0.0
1,7-	0.0	4.6
1,2-	22.1	35.9

by $2^{29,30}$. Therefore only polyhedra for $n = 5, 8, 9$, and 11 are intrinsically capable of rearrangement by a single-DSD process. But isomerizations of $n = 5$ and 9 borane and carborane polyhedra have not been observed. Meanwhile, isomerizations of carboranes for $n = 6, 7, 10$, and 12 have been reported. These isomerizations can be accounted for assuming that the rearrangements involve two or more DSD processes. These processes might occur simultaneously or consecutively. Wales and Stone have suggested that activation barriers should increase with the number of simultaneous DSD processes involved because each process requires the breaking of one bond to open a pivot face.³¹ Gimarc and Ott^{32,33} classified DSD isomerizations as forbidden if the rearrangement involved a crossing of

(29) King, R. B. *Inorg. Chim. Acta* **1981**, 49, 237.

(30) King, R. B. *Theor. Chim. Acta* **1984**, 64, 439.

(31) Wales, D. J.; Stone, A. J. *Inorg. Chem.* **1987**, 26, 3845.

(32) Gimarc, B. M.; Ott, J. J. *Inorg. Chem.* **1986**, 25, 83.

(28) Lipscomb, W. N. *Science* **1966**, 153, 275.

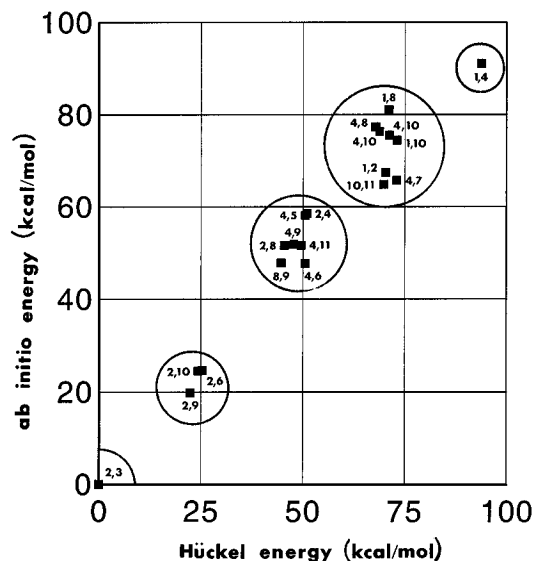
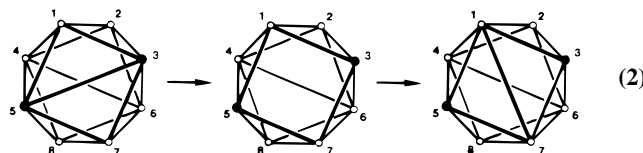

Figure 4. *Ab initio* SCF MO relative energies of $C_2B_9H_{11}$ isomers plotted against those from the perturbation treatment of 3-dimensional Hückel results. As expected, the perturbation treatment gives a tighter fit than that shown in Figure 3.

HOMO and LUMO in the transition state, a violation of the principle of conservation of orbital symmetry proposed by Woodward and Hoffmann.³⁴ They showed that such crossings occur in single-DSD processes for polyhedra of $n = 5$ and 9. Wales and Stone³¹ proposed that a process is forbidden if the transition state has a single atom lying on a principal rotational axis of 3-fold or higher. Mingos and Johnson³⁵ have put forward another rule applicable to single-DSD processes. If the four outer edges of the two fused triangles of the diamond are symmetry equivalent, the DSD process would result in a pseudorotation which is forbidden. If the edges are not symmetry equivalent, the arrangement may produce a pseudoreflexion which is symmetry allowed. *Ab initio* searches have been made for lowest energy transition states for isomerizations of $n = 5, 6, 7, 8,$ and 12 polyhedra.^{36–39} Wales has recently reported results of an *ab initio* study that shows the isomerization of the icosahedron ($n = 12$) follows a complicated sequence of single- and double-DSD processes.³⁹ King has recently reviewed the general topic of polyhedral dynamics.⁴⁰

To illustrate the complexity of *closo*-carborane isomerization pathways and the ease with which 3-dimensional Hückel theory can be applied to study energies of proposed intermediates and transition states along these paths, we present results for rearrangements for the 6-, 7-, and 8-atom carborane polyhedra. $C_2B_6H_8$ is the simplest polyhedron for which a single-DSD process is allowed. $C_2B_5H_7$ is the smallest polyhedron assumed to rearrange through a double-DSD process. The isomerization of 1, 2- $C_2B_4H_6$ to 1,6- $C_2B_4H_6$ has been observed and several processes have been suggested to account for it.

$C_2B_6H_8$. Equation 2 is the single-DSD framework reorganization for $C_2B_6H_8$. The initial and final structures are bisdisphenoids; the transition state structure is a bicapped



trigonal prism. Table 1 shows that seven isomers of $C_2B_6H_8$ are possible, but only one has been observed. The situation is complicated by the fact that optical isomers can exist for this series. In particular, there are four possible achiral isomers and three possible pairs of enantiomers for a total of 10 possible isomers:

achiral	enantiomers
1,2	1,3; 1,4
1,5	1,7; 1,8
1,6	3,5; 4,5
3,4	

Only the 1,7-isomer has been reported. Although the isoelectronic borane $B_8H_8^{2-}$ is known to be fluxional, no evidence of optical activity or fluxional racemization of 1, 7- $C_2B_6H_8$ has been mentioned in the literature. Even more isomers are possible for the bicapped trigonal prism transition state structure in eq 2: four achiral isomers and six enantiomeric pairs, a total of 16 isomers. In the following discussion we enclose within parentheses the indices of transition state isomers to distinguish them from reactant or product indices which are not enclosed.

If the solid vertices denote positions of carbon heteroatoms, eq 2 specifically shows the conversion of the 3,5-isomer to the 1,8-isomer, passing through the (3,5) transition state. By considering carbon atoms starting in all possible pairs of positions in the reactant in eq 2 and following through to product, one can construct the reaction network graph shown in Figure 5.^{21,41} In that diagram, reactant and product isomer indices appear inside circles while transition state isomer indices are in squares. The graph follows Muettterties' suggestion of a topological representation which contains two sets of vertices, G_A and G_B , one set corresponding to reactant and product isomers, while the other refers to transition state isomers.^{42,43} In Figure 5 achiral reactant, product, and transition state isomers appear on the central axis of the graph with enantiomeric pairs displayed symmetrically on either side of the axis. At the top of Figure 5 notice the degenerate rearrangement path or loop through which the 1, 5-isomer rearranges into itself through the (1,5) transition state. The reaction network graph of Figure 5 serves as a road map across the energy surface with the circles denoting relative minima and the squares indicating high points along low-energy paths connecting the minima. The minima can be associated with $C_2B_6H_8$ isomer energies in Table 2. The energy barriers between the minima can be approximated by 3-dimensional Hückel energies of transition state isomers collected in Table 4. The energies of the transition state isomers, which have one less bond than reactant and product isomers, are all far above the energies of reactants and products. Furthermore, energy differences among transition state isomers are larger than those among reactant and product isomers. Figure 6 is an energy profile along the reaction path for interconversion of $C_2B_6H_8$ isomers, ignoring loops and the racemization of enantiomers.

$C_2B_5H_7$. It is geometrically possible for the rearrangements of carborane polyhedra containing 7, 9, and 10 skeletal atoms to take place through double-DSD processes which are also

(33) Gimarc, B. M.; Ott, J. J. *Inorg. Chem.* **1986**, *25*, 2708.

(34) Woodward, R. B.; Hoffmann, R. *The Conservation of Orbital Symmetry*; Verlag Chemie, GmbH: Weinheim, 1970.

(35) Mingos, D. M. P.; Johnston, R. J. *Polyhedron* **1988**, *7*, 2437.

(36) McKee, M. L. *THEOCHEM* **1988**, *45*, 191.

(37) McKee, M. L. *J. Am. Chem. Soc.* **1988**, *110*, 5317.

(38) Wales, D. J.; Bone, R. G. A. *J. Am. Chem. Soc.* **1992**, *114*, 5399.

(39) Wales, D. J. *J. Am. Chem. Soc.* **1993**, *115*, 1557.

(40) King, R. B. In *Graph Theoretical Approach to Chemical Reactivity*; Bonchev, D., Mekenyan, O., Eds.; Kluwer Academic Publishers: Dordrecht, The Netherlands, 1994.

(41) Gimarc, B. M.; Ott, J. J. *J. Math. Chem.* **1990**, *5*, 359.

(42) Muettterties, E. L. *J. Am. Chem. Soc.* **1968**, *90*, 5097.

(43) Muettterties, E. L. *J. Am. Chem. Soc.* **1969**, *91*, 1636.

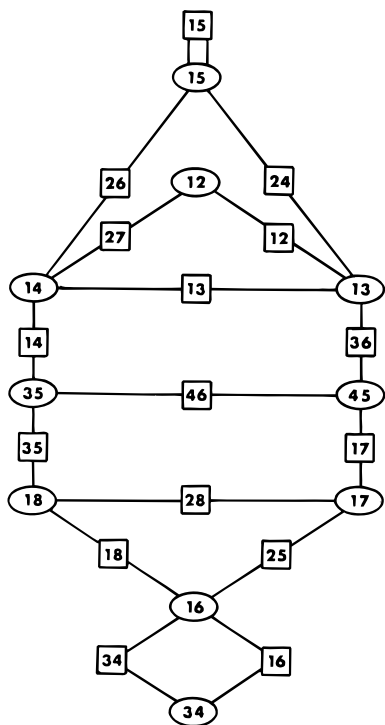
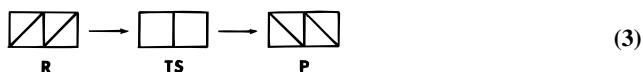

Figure 5. Reaction network graph for the isomerization of $C_2B_6H_8$ by the single-DSD mechanism, eq 2. Indices of reactant and product isomers are enclosed by circles. Those of transition state isomers are in squares. Achiral isomers are on the central axis of the graph; enantiomers are paired symmetrically on either side.

electronically allowed. Isomerizations of both 7- and 10-atom polyhedra have been observed.^{23–26,44–47} The double-DSD framework reorganizations involve two diamonds that share a common edge. In such processes the two edge-switching operations might occur simultaneously, or the second could begin only after the first is complete, or in some intermediate fashion. We call the three possibilities concerted, consecutive, or overlapping as illustrated schematically in eqs 3–5, respectively.

Concerted:



Consecutive:

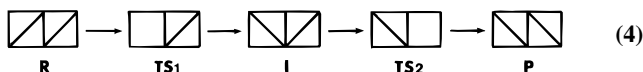

Overlapping:

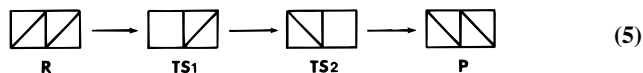

Although the three processes lead from the same initial reactant R to the same final product P, the nature of the intervening transition states and intermediates is different in each case. Onak and co-workers have tried to determine the preferred rearrange-

(44) Abdou, Z. J.; Abdou, G.; Onak, T.; Lee, S. *Inorg. Chem.* **1986**, *25*, 2678.

(45) Abdou, Z. J.; Soltis, M.; Oh, B.; Siways, G.; Banuelos, T.; Nam, W.; Onak, T. *Inorg. Chem.* **1985**, *24*, 2363.

(46) Onak, T.; Alexander, P. F.; Siwapinyoyos, G.; Leach, J. B. *Inorg. Chem.* **1979**, *18*, 2878.

(47) Oh, B.; Onak, T. *Inorg. Chem.* **1982**, *21*, 3150.

Table 4. Energies (in Units of β) of the Bicapped Trigonal Prism Transition State Isomers Involved in Eq 2 for the Isomerization of $C_2B_6H_8^a$

isomer	relative energy
(1,2), (2,7)	1.2294
(1,3)	1.1715
(1,4), (3,6)	1.2204
(1,5)	1.1877
(1,6), (3,4)	1.2091
(1,7), (3,5)	1.1563
(1,8), (2,5)	1.2131
(2,4), (2,6)	1.2751
(2,8)	1.2613
(4,6)	1.2691

^a Energies are relative to the observed isomer, 1,7- $C_2B_6H_8$.

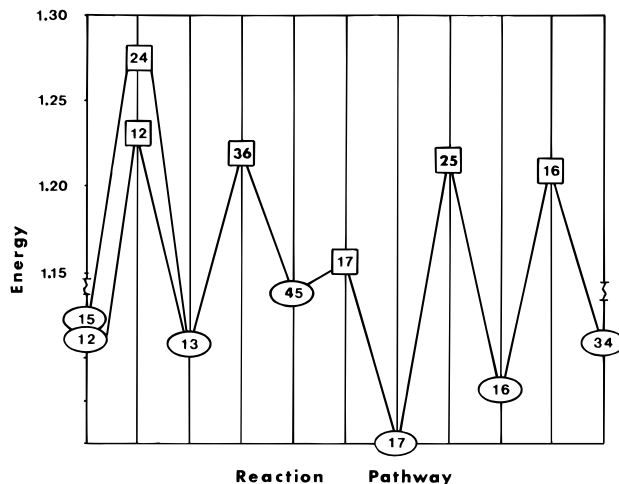
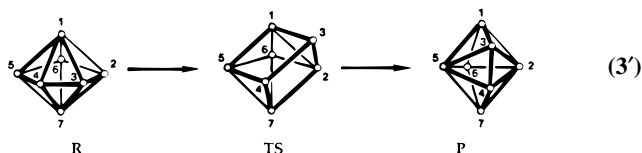

Figure 6. Energy profile along the reaction pathway for the isomerization of $C_2B_6H_8$ by eq 2. Loops and racemizations of enantiomers shown in Figure 4 have been omitted here.

ment process for $C_2B_5H_7$ by observing rearrangements of substituted carboranes.^{44–47} Following the reasoning of Wales and Stone, the deltahedral structures of R and P should have the lowest energies. To open a square or pivot face requires the expenditure of energy to break a bond. Opening two pivot faces simultaneously would cost even more. Therefore we expect energy barriers encountered along eq 3 to be higher than those found through eqs 4 and 5. King⁴⁸ has described structures such as TS in eq 3 as having a rigidity index of 2 because two bonds must be lost to form them, while the TS1 and TS2 structures of eqs 4 and 5 have rigidity indices of 1. In eq 4 structure I with all triangular faces might be expected to have lower energies than either TS1 or TS2 and correspond to an intermediate along the pathway. Equations 4 and 5 should be indistinguishable unless the intermediate I has low enough energy to be trapped along the pathway.

For $C_2B_5H_7$ Table 1 shows four isomers, two of which have been prepared, 2,4 and 2,3. The 2,4-isomer has the lower energy, and the conversion of the 2,3- to the 2,4-isomer has been observed. Equation 3' is the concerted double-DSD



isomerization for $C_2B_5H_7$. The reaction passes through a capped triangular prism transition state (TS). Figure 7 is the reaction

(48) King, R. B. *Inorg. Chem.* **1985**, *24*, 1716.

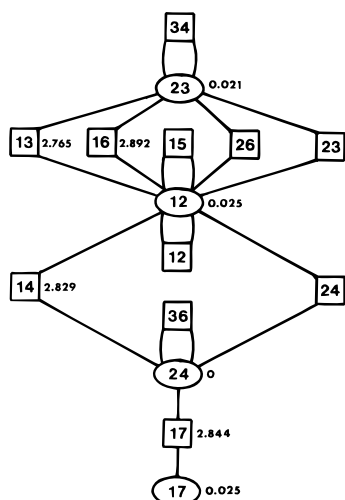

Figure 7. Reaction network graph for the interconversion of isomers of $C_2B_5H_7$ by the concerted double-DSD process, eq 3'. The four reactant and product isomers are all achiral, and their indices are enclosed in circles. Those of transition state isomers are in squares.

Table 5. Transition State and Intermediate Isomer Energies (in Units of β) for Rearrangement of $C_2B_5H_7^a$

isomer	relative energy
(a) Capped Trigonal Prism, TS, eq 3'	
(1,3)	2.7652
(1,4)	2.8291
(1,6)	2.8924
(1,7)	2.8443
(b) TS1 and TS2, eq 4'	
(1,2)	1.4293
(1,3)	1.3757
(1,4)	1.2009
(1,7)	1.4410
(2,3)	1.4775
(2,4)	1.3181
(2,5)	1.4627
(2,6)	1.5574
(2,7)	1.5591
(3,4)	1.2811
(3,5)	1.3807
(3,7)	1.4794
(4,7)	1.3574
(c) Capped Octahedron, I, eq 4'	
[1,2]	1.1601
[1,3]	1.1789
[1,4]	1.1283
[1,7]	1.1661
[3,4]	1.1423
[3,5]	1.1975

^a Energies are relative to that of the lowest energy isomer, 2,4- $C_2B_5H_7$.

network graph that relates the 4 isomers of $C_2B_5H_7$ by eq 3'. All four R and P isomers are achiral and occupy positions (in circles) on the central axis of Figure 7. There are 11 possible transition state isomers TS (in squares), including five achiral structures and three pairs of enantiomers. Loops pass through TS isomers (1,2), (1,5), (3,4), and (3,6) to regenerate a starting isomer. Since the loops do not interconvert different isomers, we ignore them in the following discussion. Since enantiomeric TS isomers have identical energies, we consider only four different TS isomers, and their energies, relative to that of the lower energy observed isomer 2,4- $C_2B_5H_7$, are listed in Table 5a. The reaction network graph, Figure 7, shows two different paths connecting 2,3 and 1,2, one passing through TS isomer (1,3) and the other through (1,6). The 3-dimensional Hückel

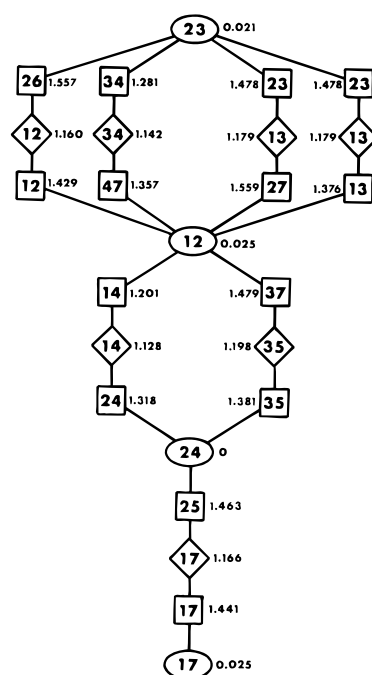
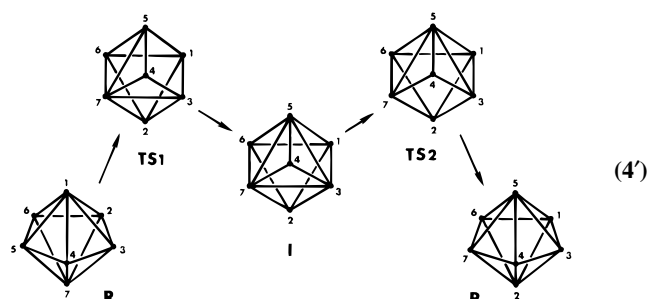

Figure 8. Reaction network graph for the isomerization of $C_2B_5H_7$ by the consecutive double-DSD process, eq 4'. Arrangement of the diagram implies nothing about the chirality of transition state and intermediate isomers.

results show that the (1,3) pathway presents a much lower activation barrier.

Figure 8 is the reaction network graph for the isomerization of $C_2B_5H_7$ through the consecutive double-DSD mechanism of eq 4'. In Figure 8 the indices of the four reactant and product isomers, R and P, are enclosed in circles, transition state isomers, TS1 and TS2, are in squares, and intermediate isomers I are in diamonds. The reaction network graph shows one route joining 2, 4- and 1, 7-, two different pathways linking 1,2 and 2,4, and four different processes connecting 1,2 and 2,3. Energies of transition state isomers TS1 and TS2 appear in Table 5b, and those of intermediate isomers I are in Table 5c. These energies are relative to the lowest energy 2,4-isomer. From the transition state energies we conclude that the low-energy path from 1,2 to 2,4 is through (1,4), [1,4], (2,4), while the lowest activation barrier between 2,3 and 1,2 is along (3,4), [3,4], (4,7). Here we use square brackets to denote indices of isomers of the intermediates I. Notice that the intermediate isomers, of capped octahedral geometry and therefore deltahedral, have lower energies than transition state isomers which contain one square face. But the intermediate isomers have higher energies than reactant and product isomers which have the preferred deltahedral form. Furthermore, the TS1 and TS2 isomers, with one pivot face in eq 4', are lower in energy than the capped trigonal



prism isomers TS, with two pivot faces, involved in eq 3'. Thus, trends in 3-dimensional Hückel energies for transition state and

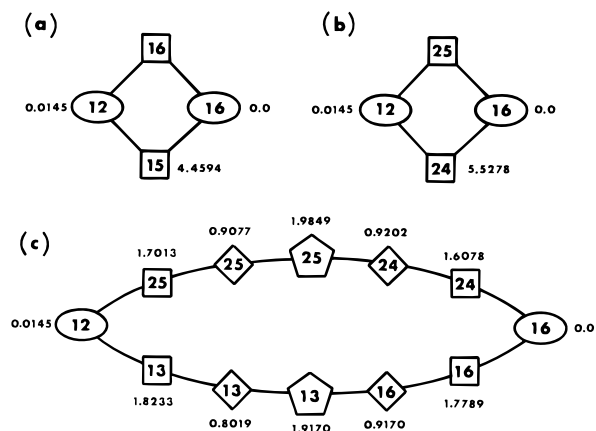
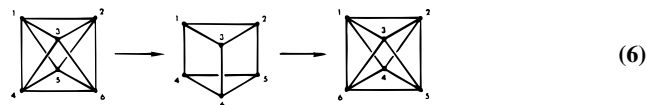

Figure 9. Reaction network graphs for the interconversion of 1,2- and 1,6-isomers of $C_2B_4H_6$: (a) concerted triple-DSD, eq 6, (b) edge-twist, eq 7, and (c) consecutive triple-DSD, eq 8. The lowest path is through eq 8.

intermediate structures follow the expected trends but allow us to predict which path will have lowest energy in cases where multiple pathways are possible.

$C_2B_4H_6$. The conversion of 1,2- $C_2B_4H_6$ to the 1,6-isomer has been observed at 250 °C.⁴⁹ The activation energy for this reaction has been estimated to be 42–45 kcal/mol.⁵⁰ The mechanism of isomerization is unknown, but at least three different processes have been proposed. Equation 6 is the concerted triple-DSD mechanism. Imagine the 4,5,6 triangle



rotating by 120° relative to a fixed 1,2,3 triangle and carrying the structure through a trigonal prism transition state.²⁸ This process is sometimes called the triangular face twist.

The trigonal prism intermediate has two possible achiral isomers and a pair of enantiomers. With two carbon atoms starting at all possible pairs of positions in the reactant in eq 6, one can show that only the enantiomeric pair of trigonal prism transition state isomers, (1,5) and (1,6), are involved in the 1,2- to 1,6- isomerization. The reaction network graph for eq 6, omitting loops and multiple equivalent edges, appears in Figure 9a. Numbers beside the isomer indices are 3-dimensional Hückel energies of various isomers relative to the lowest energy structure 1,6- $C_2B_4H_6$.

Equation 7 shows the edge-twist mechanism for isomerization of $C_2B_4H_6$.⁵⁰ Imagine twisting the 2–3 bond around an axis that runs from the center of the octahedron through the midpoint of the 2–3 bond. The transition state has a benzvalene-like structure in which four of the 12 bonds of the octahedron have been lost. While the deltahedral structures of the *closo*-boranes and -carboranes are highly electron deficient, the benzvalene structures of $C_2B_4H_6$ are classical in that 13 bonds (including six C–H and B–H bonds) are exactly satisfied by the 26 valence electron pairs available. The benzvalene transition state has nine possible isomers including five achiral structures and two pairs of enantiomers. For the interconversion of 1,2- and 1,6- $C_2B_4H_6$, only the (2,4), (2,5) benzvalene enantiomeric pair is involved. Figure 9b shows the reaction

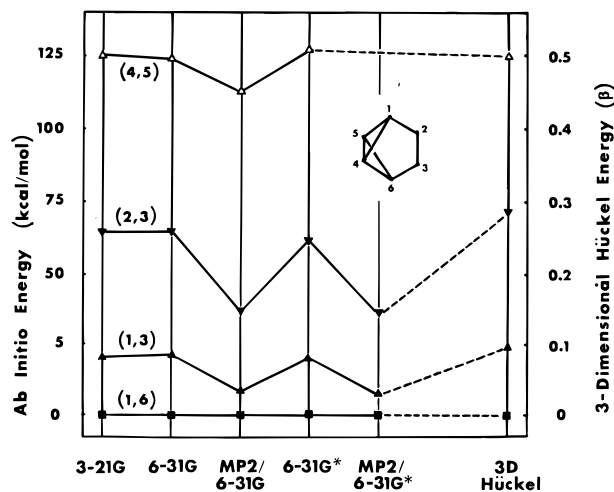
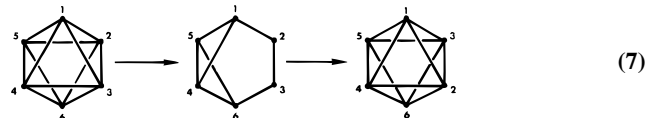

Figure 10. Relative energies of benzvalene-like transition state isomers, eq 7, calculated by *ab initio* and 3-dimensional Hückel methods.

network graph corresponding to eq 7, but lacking loops and



multiple equivalent edges. In Figure 9b the value 5.5287 β represents the height of the (2,4), (2,5) benzvalene isomer activation barrier above the energy of the 1,6- $C_2B_4H_6$ ground state.

In a study of the edge-twist isomerization mechanism, McKee⁵¹ carried out geometry-optimized *ab initio* SCF MO calculations for the benzvalene intermediate isomers (1,3), (1,6), (2,3), and (4,5). These achiral isomers have C_{2v} or C_s symmetry. His attempts to optimize the geometry of a member of the (2,4), (2,5) enantiomeric pair actually encountered along the 1,2- to 1,6-isomerization pathway led to a completely different structure. McKee's *ab initio* results for four benzvalene isomers allow another direct comparison of *ab initio* and 3-dimensional Hückel relative energies, and these are shown in Figure 10. McKee used three different basis sets, and for two of them he reported both RHF and MP2 results. Geometries for all his calculations were determined with the 3-21G basis set. In Figure 10 we set the difference between 3-dimensional Hückel energies (in units of β) of highest and lowest isomers to match that from *ab initio* results (in kcal/mol). For the four benzvalene-like intermediate isomers, the 3-dimensional Hückel energies follow the same energy order as the *ab initio* results.

Equation 8 presents an alternative mechanism proposed by Johnson⁵¹ that we describe as a consecutive triple-DSD process. Of the 15 possible processes connecting R and P, only six

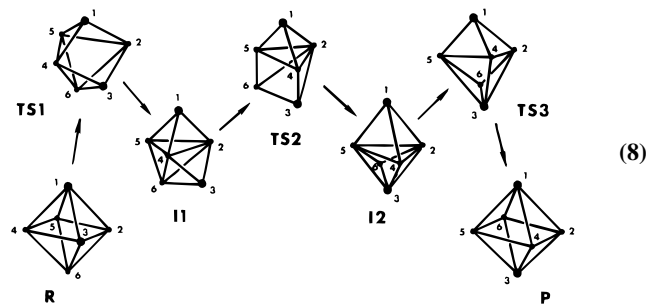

(49) Onak, T.; Drake, R. P.; Dunks, G. B. *Inorg. Chem.* **1964**, *3*, 1686.

(50) Halgren, T. A.; Pepperberg, I. M.; Lipscomb, W. N. *J. Am. Chem. Soc.* **1975**, *97*, 1248.

(51) McKee, M. L. *J. Am. Chem. Soc.* **1988**, *110*, 5317.

actually produce isomerization, and among these there are only two different paths. Representative starting positions in R for the two paths are 1,3 and 2,5. Structures labeled TS1, TS2, and TS3 each have one square face and should be transition states with higher energies than the deltahedral structures R, P, I1, and I2. The capped trigonal bipyramids I1 and I2 should be intermediates with energies lower than the transition states but higher than those of the preferred octahedral R and P.

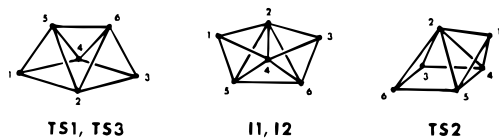

The capped square pyramid TS2 resembles the “sagging sawhorse” (distorted trigonal prism) identified in a PRDDO method search by Lipscomb and co-workers⁵⁰ but subsequently discounted in favor of a benzvalene-like intermediate.⁵³ Figure 9c is the reaction network graph corresponding to eq 8, omitting loops and multiple equivalent edges. The high point along both paths occurs at TS2 with the barrier [2,5] higher than [1,3]. These paths are much lower in energy than those for eqs 6 and 7, fulfilling our expectations that mechanisms involving transition state structures with a single square face should be preferred compared to those that pass through structures with three squares or even larger rings.

More recently McKee has made another attempt to discover the mechanism of $C_2B_4H_6$ isomerization.⁵⁴ He used *ab initio*

calculations with the 6-31G* basis set and including MP2 and MP4 calculations for single points of special interest along the reaction path. The structures of his transition states resemble the benzvalene-like intermediate of eq 7 and the TS1 and TS3 structures of eq 8. Calculated activation energies are in agreement with experimental results.

Conclusions

Calculations of the relative energies of isomers of the *closo*-carboranes by the three-dimensional Hückel method are generally in agreement with experimental observations and *ab initio* results although some discrepancies occur. Compared to energy orders obtained by direct solution of the heteroatomic secular equation, a 3-parameter perturbation treatment produces only modest improvement. As a semiquantitative method, the 3-dimensional Hückel theory yields acceptable results.

In applications to calculations of energies of intermediate and transition state structures along pathways assumed for carborane isomerizations, the 3-dimensional Hückel method prefers deltahedral structures to polyhedra with one square face which, in turn, are preferred to those with two square faces and so on. These are the same conclusions one gets from a qualitative rule that says breaking bonds to open square faces should raise the energy of the resulting polyhedral structure, but this rule may not always be correct. The 3-dimensional Hückel method seriously overestimates the energies of the benzvalene-like structures proposed as intermediates in the isomerization of $C_2B_4H_6$.

Acknowledgment. We are grateful to the National Science Foundation for partial support of this research through Grant No. CHE-9012216 to the University of South Carolina.

IC9506668

(52) Johnson, B. F. *J. Chem. Soc., Chem. Commun.* **1986**, 27.

(53) Camp, R. N.; Marynick, D. S.; Graham, G. D.; Lipscomb, W. N. *J. Am. Chem. Soc.* **1978**, *100*, 6781.

(54) McKee, M. L. *J. Am. Chem. Soc.* **1992**, *114*, 879.